

Varenummer: 0106033
 Beskrivelse: Seeger låsering JV 17

Mål

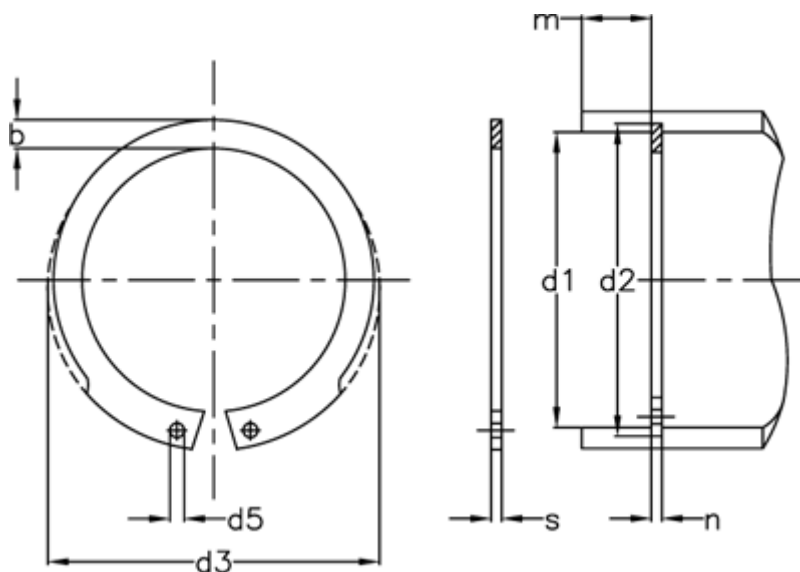

AN mm ²	= 11	FRg kN	= 3.0	Tang	= ZGJ-1
b	= 2.1	FR kN	= 5.8	tol	= -0.06
Betegnelse	= JV 17	g	= 1.0	tol	= +0,42-0,13
d1	= 17	K kN-mm	= 21.2	tol	= +0,11
d2	= 17.8	m min	= 1.10	tol	= 0.1
d3	= 18.3	Nominel træk	= 1.5	vægt kg/1000	= 0.58
d5 min	= 1.3	s	= 1.00		
FN kN	= 1.70	t	= 0.40		